

RoHS2.0
Compliant

0.15

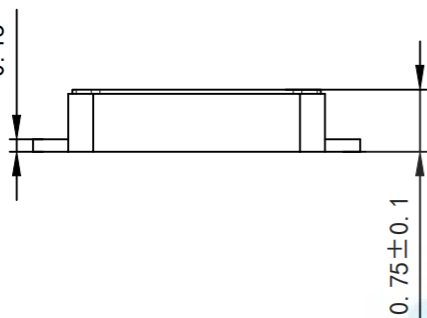

0.75±0.1

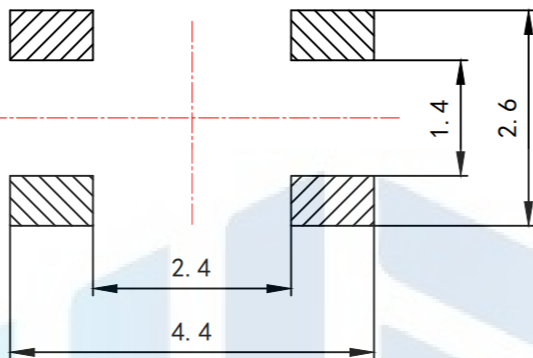

PCB. 焊接图

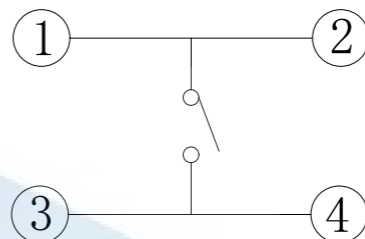

电路图

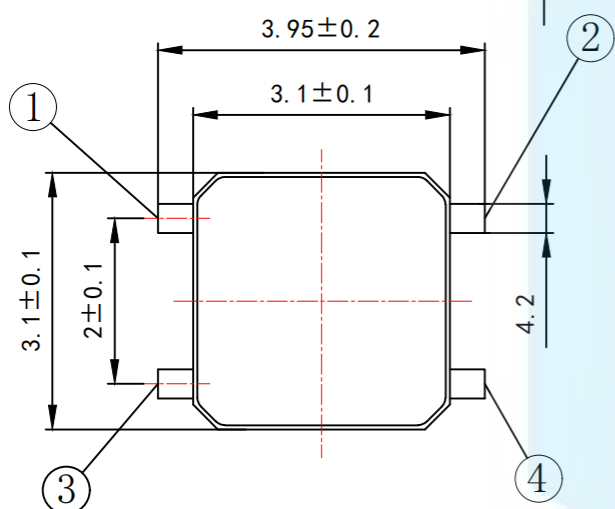
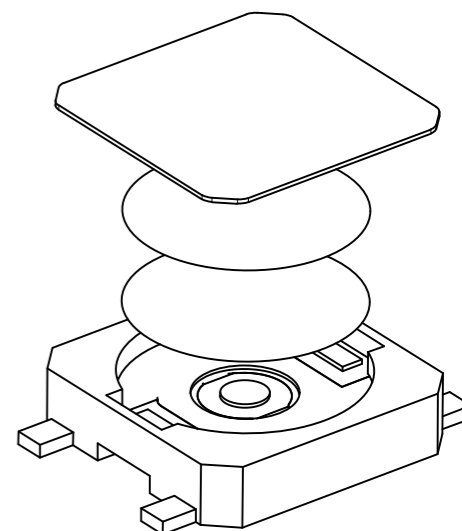

3.95±0.2

3.1±0.1

3.1±0.1

2±0.1

4.2

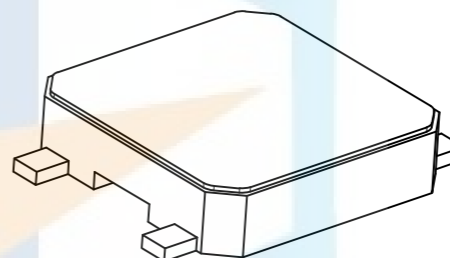

Key Technical Specifications:

1. Rating: 50mA DC12V
2. Contact resistance: $\leq 100m\Omega$
3. Operating force: $250 \pm 40gf$
4. Itinerary: $0.20 \pm 0.1mm$
5. Insulation resistance: $\geq 100M\Omega$
6. Electrical strength: 250V 50HZ 1Min.
7. life span: 100,000 Cycles

TOLERANCE

X. XXX	± 0.05
X. XX	± 0.15
X. X	± 0.20
X.	± 0.30
ANGLE	$\pm 5.0^\circ$

PROTECTON

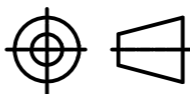

东莞市恒祺电子科技有限公司

Dongguan Hengqi Electronic Technology Co., Ltd

<https://www.hq-dz.com>

phone: 15812872448

TITLE:

薄膜轻触开关

PART NO: HQ-TS-A006

DRAWING NO: 3*3*0.75

DRAWN:

DATE:

18-10-08

UNIT:
mm

CHECKED:

DATE:

18-10-08

SCALE:
FULL

APPROVED:

DATE:

18-10-08

SIZE:
A4