

RoHS2.0
Compliant

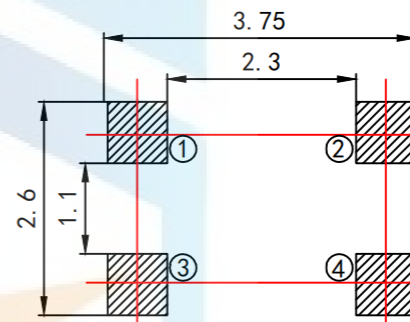

P. C. B. Layout

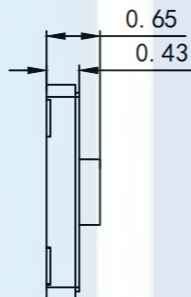
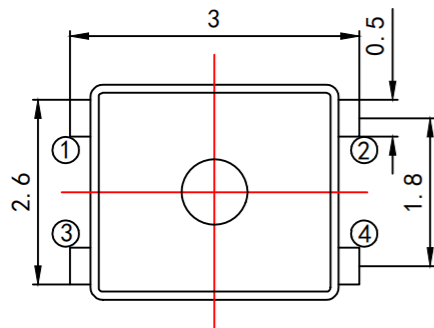
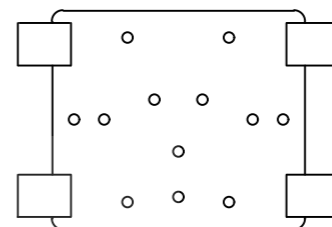
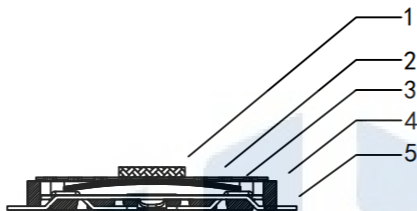
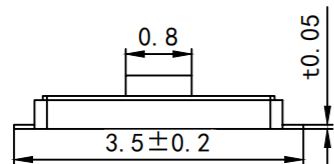
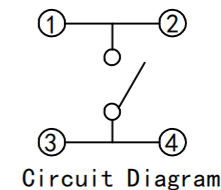

Remarks:

1. Rated current, Voltage: DC 12V 50mA
2. Contact resistance: <100mΩ
3. Insulation resistance: >100MΩ
4. The intensity of operations: 160~300 ± 50gf
5. Life requirements: 100000 times
6. Withstand voltage: AC250V 1 minute
7. All materials comply with RoHS standards

TOLERANCE

X. XXX	±0.05
X. XX	±0.15
X. X	±0.20
X.	±0.30
ANGLE	±5.0°

PROTECTON

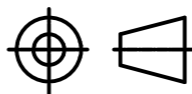

东莞市恒祺电子科技有限公司

Dongguan Hengqi Electronic Technology Co., Ltd

<https://www.hq-dz.com>

phone: 15812872448

TITLE:

薄膜轻触开关
平脚黄膜带点

PART NO: QH-TS-A014B

DRAWING NO: 2.6*3*0.6

DRAWN:

DATE:

18-10-08

UNIT:
mm

CHECKED:

DATE:

18-10-08

SCALE:
FULL

APPROVED:

DATE:

18-10-08

SIZE:
A4