

RoHS2.0
Compliant

SPECIFICATION:

1. Rated voltage :DC 50V 0.3A
2. Contact resistance :30MΩ MAX less than 30MΩ
3. Insulation resistance :100MΩ MIN 100 megohm or more
4. Compressive strength :AC500V (50/60Hz) 1 minute sensitivity current is 0.5mA
5. Operating temperature: -16°C ± 60°C
6. Mechanical life: 10,000 cycles

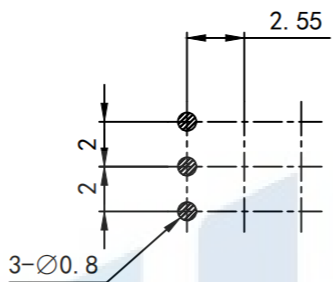

P. C. B LAYOUT

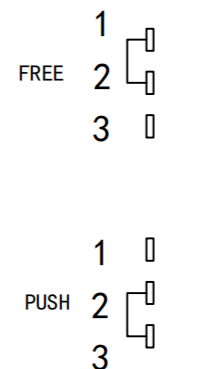
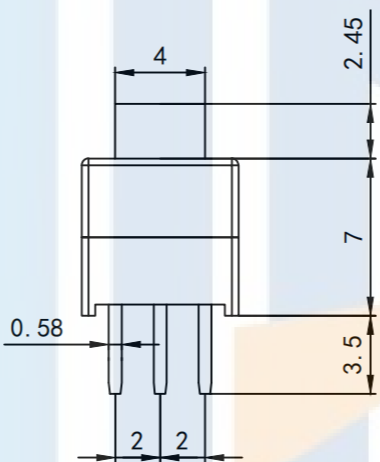
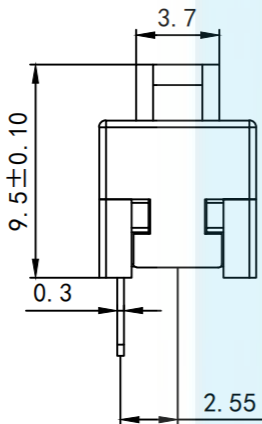

CIRCUIT DIAGRAM

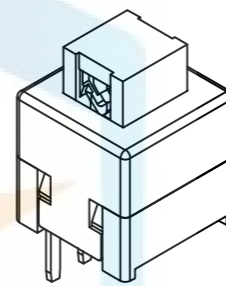

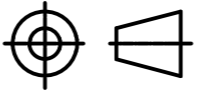
TOLERANCE X. XXX ±0.05 X. XX ±0.15 X. X ±0.20 X. ±0.30 ANGLE ±5.0°		 东莞市恒祺电子科技有限公司 Dongguan Hengqi Electronic Technology Co., Ltd		
		https://www.hq-dz.com phone:15812872448		
TITLE: 按键开关 自(无)锁		PART NO: 7*7单排平头边三脚		
		DRAWING NO: 7*7*9.5		
PROTECTON 		DRAWN:	DATE: 18-10-08	UNIT: mm
		CHECKED:	DATE: 18-10-08	SCALE: FULL
		APPROVED:	DATE: 18-10-08	SIZE: A4

