

RoHS2.0
Compliant

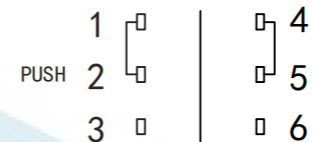

CIRCUIT DIAGRAM

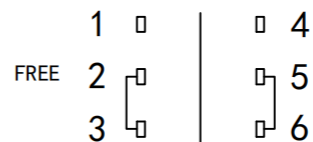
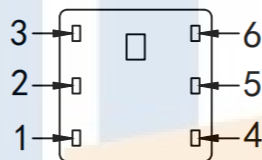
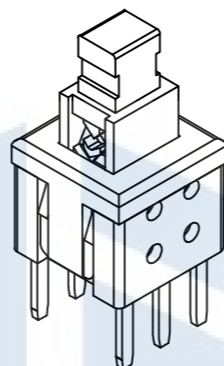
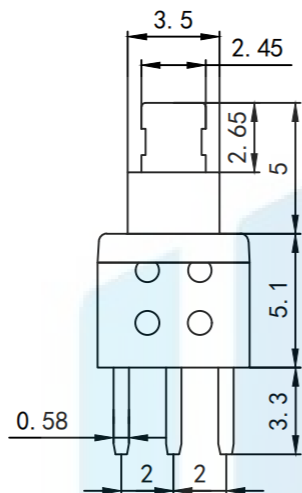
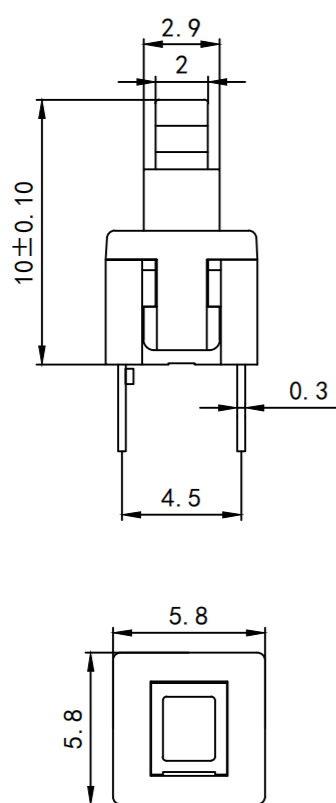
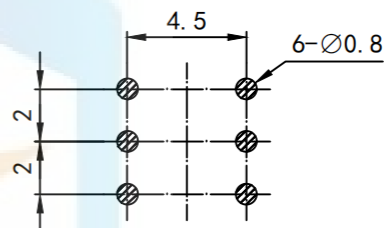

P. C. B LAYOUT

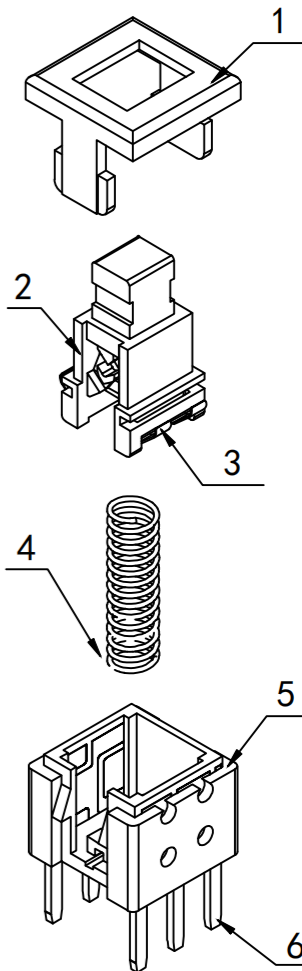

SPECIFICATION:

1. Rated voltage :DC 50V 0.3A
2. Contact resistance :30MΩ MAX less than 30Mω
3. Insulation resistance :100MΩ MIN 100 megohm or more
4. Compressive strength :AC500V (50/60Hz)1 minute sensitivity current is 0.5mA
5. Operating temperature: -16°C±60°C
6. Mechanical life: 10,000 cycles

TOLERANCE

X. XXX	±0.05
X. XX	±0.15
X. X	±0.20
X.	±0.30
ANGLE	±5.0°

PROTECTON

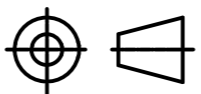

东莞市恒祺电子科技有限公司
Dongguan Hengqi Electronic Technology Co., Ltd

<https://www.hq-dz.com>

phone:15812872448

TITLE:

按键开关
自(无)锁

PART NO:5.8*5.8双排高头6脚

DRAWING NO:5.8*5.8*10脚高3.3

DRAWN:

CHECKED:

APPROVED:

DATE:

DATE:

DATE:

18-10-08

18-10-08

18-10-08

UNIT:
mm

SCALE:
FULL

SIZE:
A4

RoHS2.0
Compliant

SPECIFICATION:

1. Rated voltage :DC 50V 0.3A
2. Contact resistance :30MΩ MAX less than 30Mω
3. Insulation resistance :100MΩ MIN 100 megohm or more
4. Compressive strength :AC500V (50/60Hz) 1 minute sensitivity current is 0.5mA
5. Operating temperature: -16°C±60°C
6. Mechanical life: 10,000 cycles

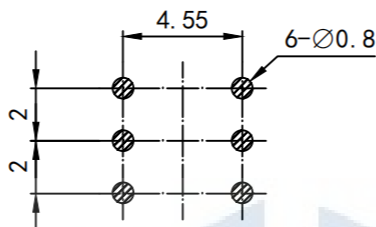

P. C. B LAYOUT

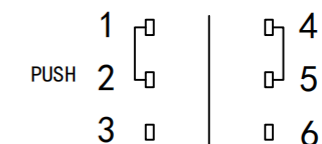
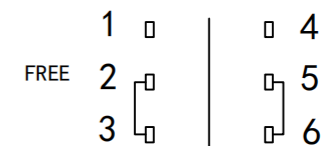
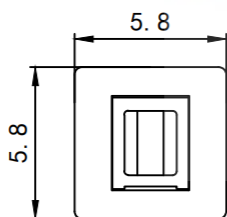
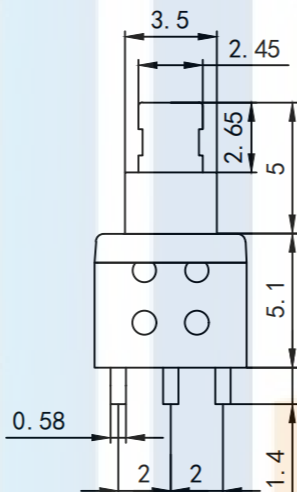
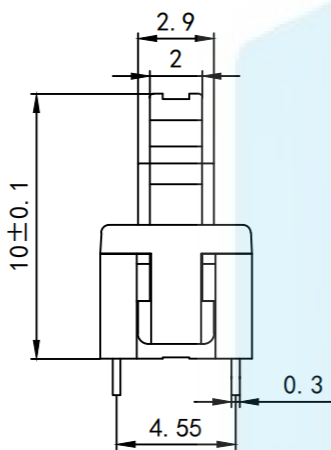

CIRCUIT DIAGRAM

TOLERANCE X. XXX ±0.05 X. XX ±0.15 X. X ±0.20 X. ±0.30 ANGLE ±5.0°		东莞市恒祺电子科技有限公司 Dongguan Hengqi Electronic Technology Co., Ltd		
		https://www.hq-dz.com phone:15812872448		
PROTECTON 	TITLE: 按键开关 自(无)锁		PART NO: 5.8*5.8双排6脚高头	
	DRAWN:		DRAWING NO: 5.8*5.8*10脚高1.4	
	CHECKED:	DATE: 18-10-08	UNIT: mm	SCALE: FULL
APPROVED:	DATE: 18-10-08	DATE: 18-10-08	SIZE: A4	

RoHS2.0
Compliant

SPECIFICATION:

1. Rated voltage :DC 50V 0.3A
2. Contact resistance :30MΩ MAX less than 30Mω
3. Insulation resistance :100MΩ MIN 100 megohm or more
4. Compressive strength :AC500V (50/60Hz) 1 minute sensitivity current is 0.5mA
5. Operating temperature: -16°C±60°C
6. Mechanical life: 10,000 cycles

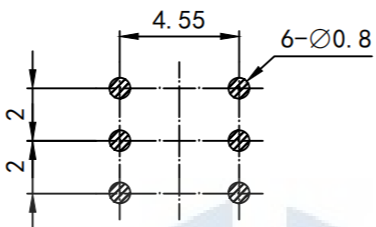

P. C. B LAYOUT

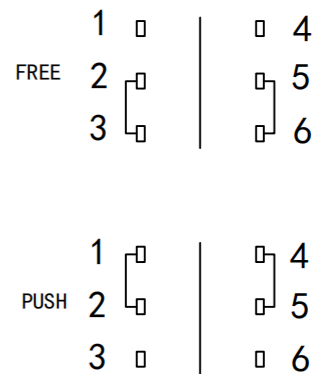
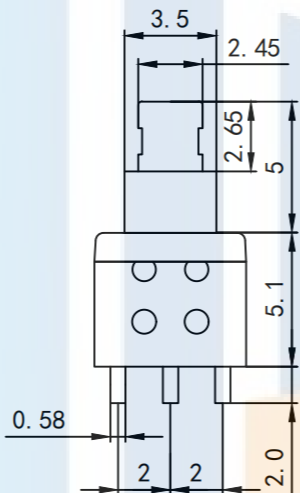
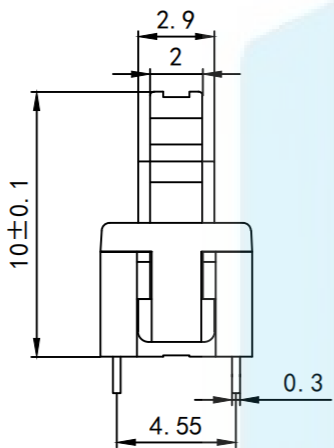

CIRCUIT DIAGRAM

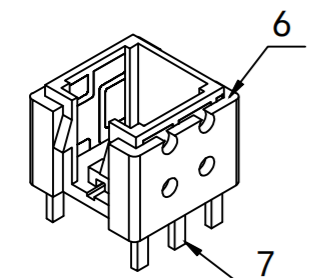
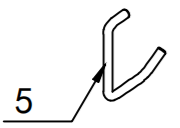
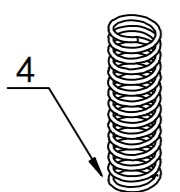
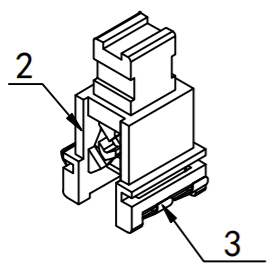
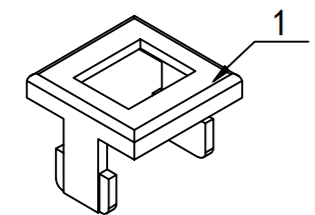

TOLERANCE X. XXX ±0.05 X. XX ±0.15 X. X ±0.20 X. ±0.30 ANGLE ±5.0°		东莞市恒祺电子科技有限公司 Dongguan Hengqi Electronic Technology Co., Ltd		
		https://www.hq-dz.com phone:15812872448		
PROTECTON 	TITLE: 按键开关 自(无)锁		PART NO:5.8*5.8双排6脚高头	
	DRAWN:		DRAWING NO:5.8*5.8*10脚高2.0	
	CHECKED:		DATE: 18-10-08	
APPROVED:		DATE: 18-10-08		UNIT: mm
		DATE: 18-10-08		SCALE: FULL
		DATE: 18-10-08		SIZE: A4

RoHS2.0
Compliant

SPECIFICATION:

1. Rated voltage :DC 50V 0.3A
2. Contact resistance :30MΩ MAX less than 30MΩ
3. Insulation resistance :100MΩ MIN 100 megohm or more
4. Compressive strength :AC500V(50/60Hz) 1 minute sensitivity current is 0.5mA
5. Operating temperature: -16°C±60°C
6. Mechanical life: 10,000 cycles

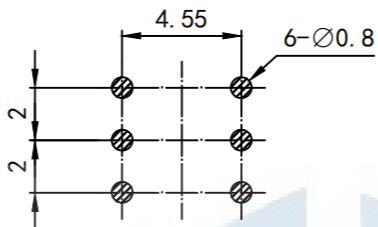
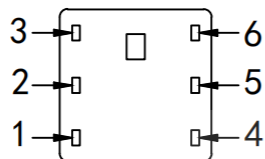

P. C. B LAYOUT

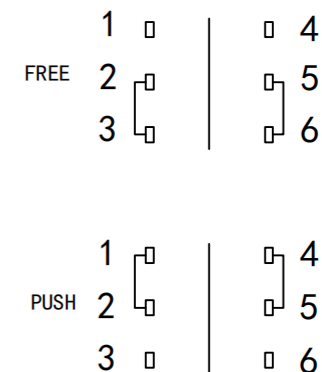
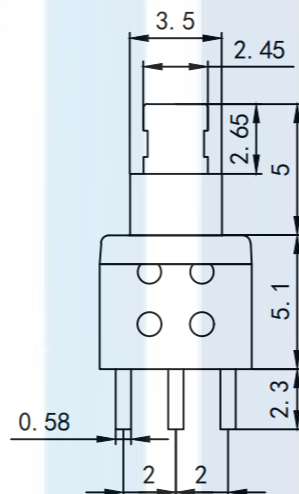
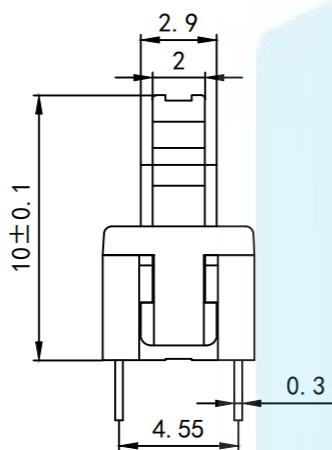

CIRCUIT DIAGRAM

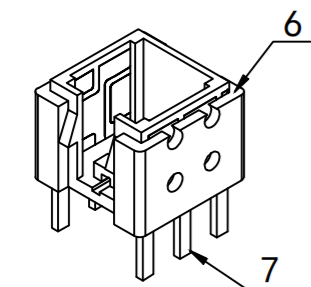
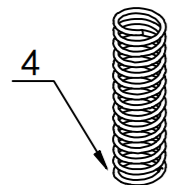
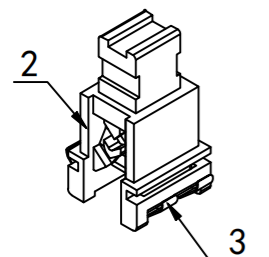
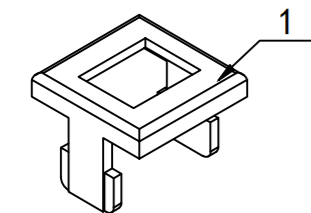

TOLERANCE X. XXX ±0.05 X. XX ±0.15 X. X ±0.20 X. ±0.30 ANGLE ±5.0°		东莞市恒祺电子科技有限公司 Dongguan Hengqi Electronic Technology Co., Ltd	
		https://www.hq-dz.com phone:15812872448	
PROTECTON 	TITLE: 按键开关 自(无)锁		PART NO:5.8*5.8双排6脚高头
	DRAWN:		DRAWING NO:5.8*5.8*10脚高2.3
	CHECKED:	DATE: 18-10-08	UNIT: mm
APPROVED:	DATE: 18-10-08	SCALE: FULL	
	DATE: 18-10-08	SIZE: A4	