

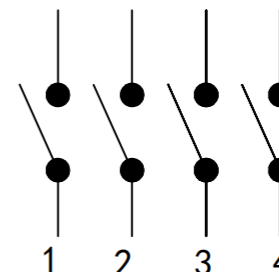

RoHS2.0
Compliant ✓

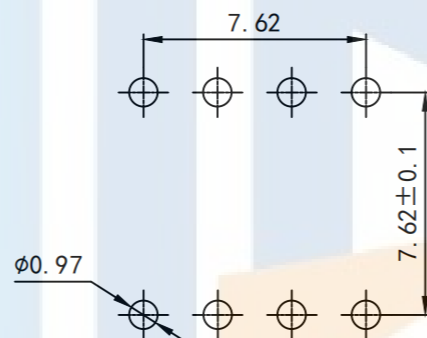
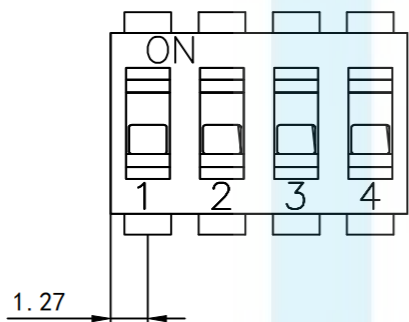
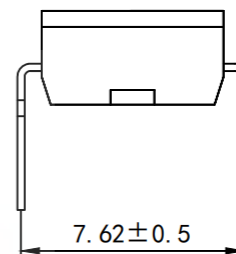
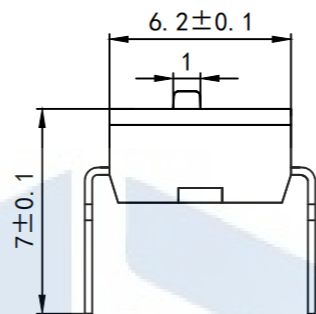
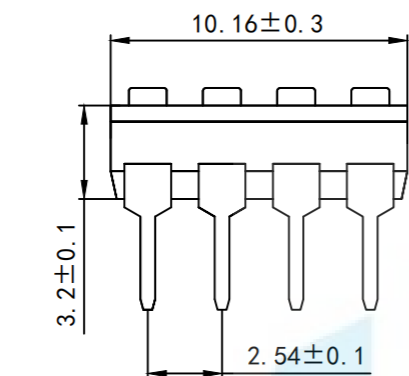
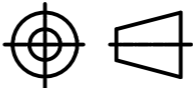

Specification:
 Electrical life: 2000 times
 rated current:
 No Switching: 100mA@50VDC
 Switching: 25mA @ 24VDC
 Insulation Resistance: 100MΩ@250VDC
 Contact Resistance: 50mΩ max
 Dielectric strength: 500VAC/1min
 Operating force: 500gfmax
 Operating temperature: -30°C to 85°C (no ice)

TOLERANCE X. XXX ±0.05 X. XX ±0.15 X. X ±0.20 X. ±0.30 ANGLE ±5.0°	 东莞市恒祺电子科技有限公司 Dongguan Hengqi Electronic Technology Co., Ltd https://www.hq-dz.com phone:15812872448	TITLE: 拨码开关		PART NO:BIH004	
		DRAWING NO:10.16*3.2*2.54		DRAWN:	
PROTECTON 	CHECKED:		DATE: 18-10-08	SCALE: FULL	
	APPROVED:		DATE: 18-10-08	SIZE: A4	
	DATE: 18-10-08				