

RoHS2.0
Compliant

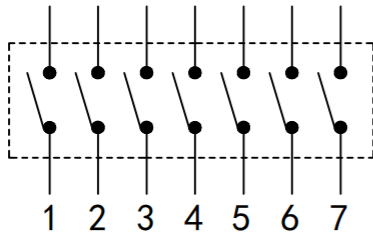

电路图

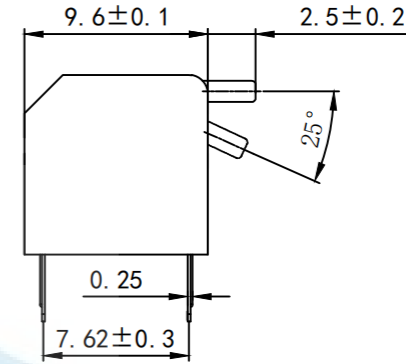
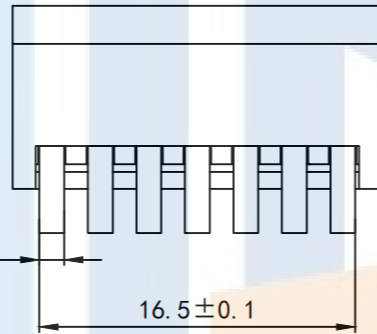
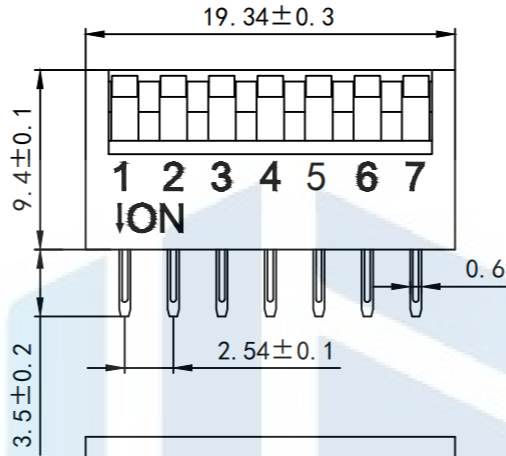

长拨柄(L)

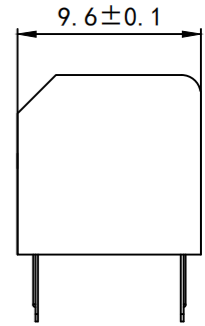

短拨柄(R)

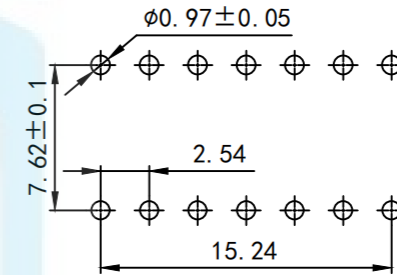

PCB开孔

Switching features:

1. Lifting capacity: 25mA at 24VDC
2. Insulation resistance: 100MΩ at 250VDC
3. Contact resistance: 50mΩ max
4. Dielectric strength: 500VAC /1min,
5. Operating force: 1000gf max
6. Electrical life: 2000 times
7. Applicable temperature: -20°C to 70°C (no icing)
8. Welding requirements:
 Manual soldering: 320°C no more than 2seconds, (30 watt soldering iron max).
 Wave soldering: 260°C no more than 5 seconds, the switch is in a disconnected state during soldering and cleaning
9. The switch is in a disconnected state when leaving the factory.

TOLERANCE

X. XXX	±0.05
X. XX	±0.15
X. X	±0.20
X.	±0.30
ANGLE	±5.0°

PROTECTON

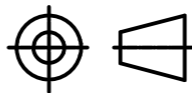

东莞市恒祺电子科技有限公司

Dongguan Hengqi Electronic Technology Co., Ltd

<https://www.hq-dz.com>

phone: 15812872448

TITLE:

拨码开关

PART NO: DPL007

DRAWING NO: 19.34*9.4*2.54

DRAWN:

DATE: 18-10-08

UNIT: mm

CHECKED:

DATE: 18-10-08

SCALE: FULL

APPROVED:

DATE: 18-10-08

SIZE: A4