

RoHS2.0
Compliant ✓

H	3	特长排
	3.5	短排
	4.8	常规
	6.5	长排
	9	加长排

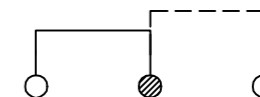

SCHEMATIC (NON-SHORTING)

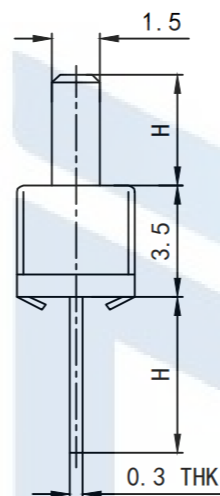
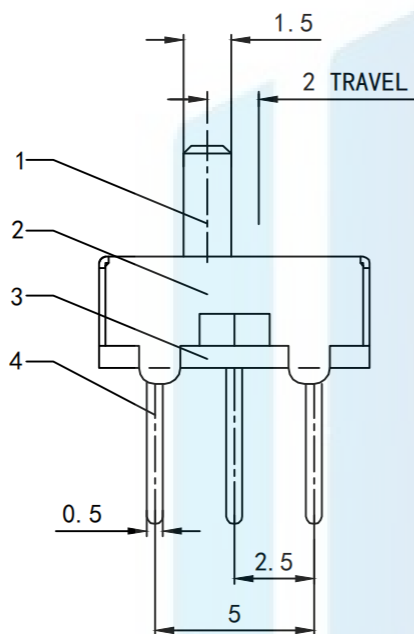
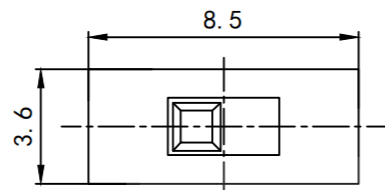
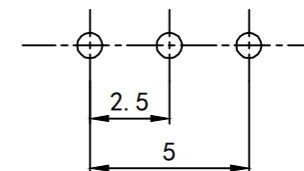

Rated voltage :DC 50V 0.3A
 Contact resistance :30MΩ MAX less than 30MΩ
 Insulation resistance :100MΩ MIN 100 megohm or more
 Compressive strength :AC500V (50/60Hz) 1 minute sensitivity current is 0.5mA
 Operating temperature: -16°C ±60°C
 Mechanical life: 10,000 cycles

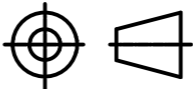
TOLERANCE X. XXX ±0.05 X. XX ±0.15 X. X ±0.20 X. ±0.30 ANGLE ±5.0°		东莞市恒祺电子科技有限公司 Dongguan Hengqi Electronic Technology Co., Ltd	
		https://www.hq-dz.com phone:15812872448	
PROTECTON 	DRAWN:	DATE: 18-10-08	UNIT: mm
	CHECKED:	DATE: 18-10-08	SCALE: FULL
	APPROVED:	DATE: 18-10-08	SIZE: A4
TITLE: 拨动开关		PART NO: SS-12D00	
		DRAWING NO: 8.5*3.6*H	