

RoHS2.0
Compliant

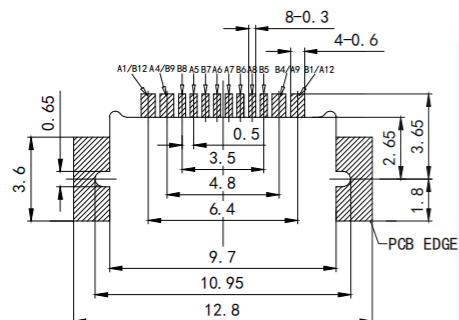

RECOMMEND P. C. B LAYOUT
TOLERANCE UNSPECIFIED ± 0.05

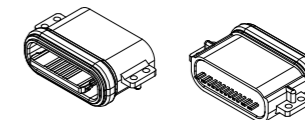
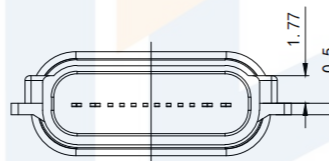
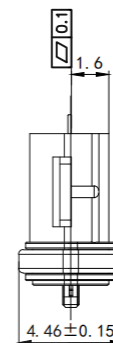
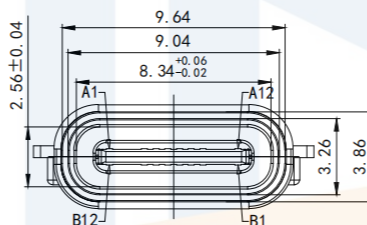
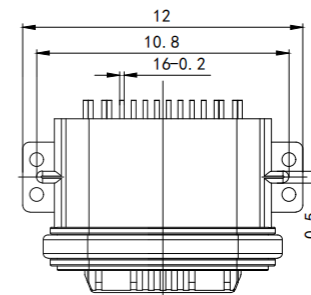
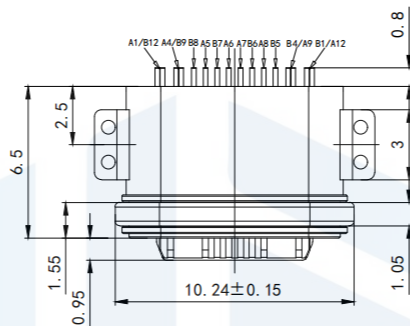

- NOTES:
SPECIFICATION:
- CURRENT RATING: 3.0 A
 - VOLTAGE RATING: 3.0 V
 - VBUS & GND PINS AND OTHER PINS: 40mΩ/PIN MAX
SHIELD: 50mΩ/MAX LLGR MAX. CHANGE OF ALL PINS: 10Ωm
 - INSULATION RESISTANCE: 100MΩ MIN
 - DIELECTRIC WITHSTAND VOLTAGE, AC 100V FOR 1MINUTE
 - INSERTION FORCE: 0.5~2.0kgf
 - UNMATING FORCE: 0.8-2.0kgf
 - DURABILITY: 10000 CYCLES
 - OPERATING TEMPERATURE: -35° C~+85° C
 - THE PEAK TEMPERATURE ON THE BOARD SHALL BE MAINTAINED FOR 10 SECONDS AT 210-230° C
 - WATERPROOF: IP-X7.

TOLERANCE			东莞市恒祺电子科技有限公司		
X. XXX	±0.05		Dongguan Hengqi Electronic Technology Co., Ltd		
X. XX	±0.15	https://www.hq-dz.com		phone:15812872448	
X. X	±0.20	TITLE:		PART NO:TYPE-C16P-CB116FS	
X.	±0.30	TYPE C 16P 防水母座沉板1.6 L=6.5mm粉末冶金		DRAWING NO:10.24*4.46*6.5	
ANGLE	±5.0°	PROTECTON		DATE: 18-10-08	
		DRAWN:		UNIT: mm	
		CHECKED:		SCALE: FULL	
		APPROVED:		DATE: 18-10-08	
				SIZE: A4	