

RoHS2.0  
Compliant

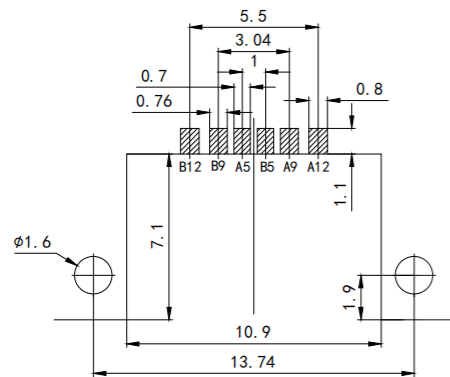

RECOMMEND P. C. B LAYOUT (COMPONENT SIDE)  
TOLERANCE FOR PCB LAYOUT IS  $\pm 0.05$

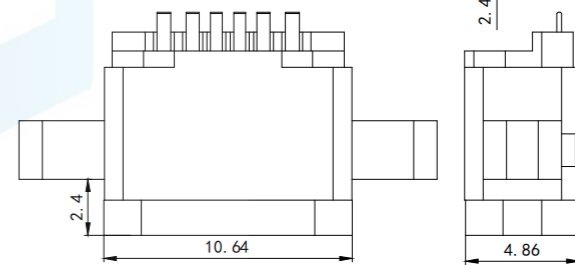
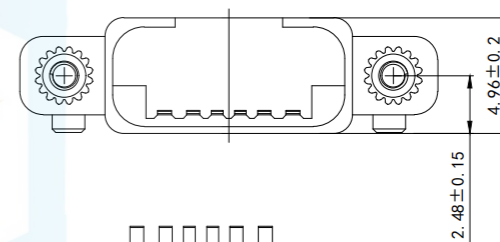
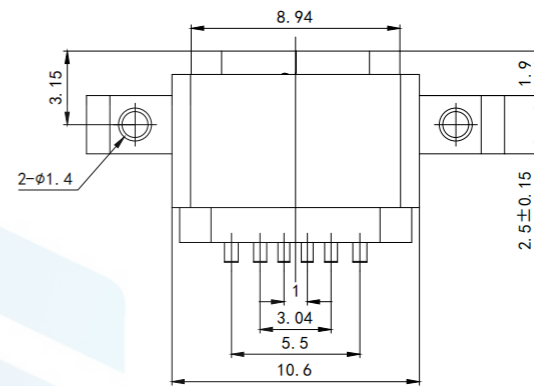
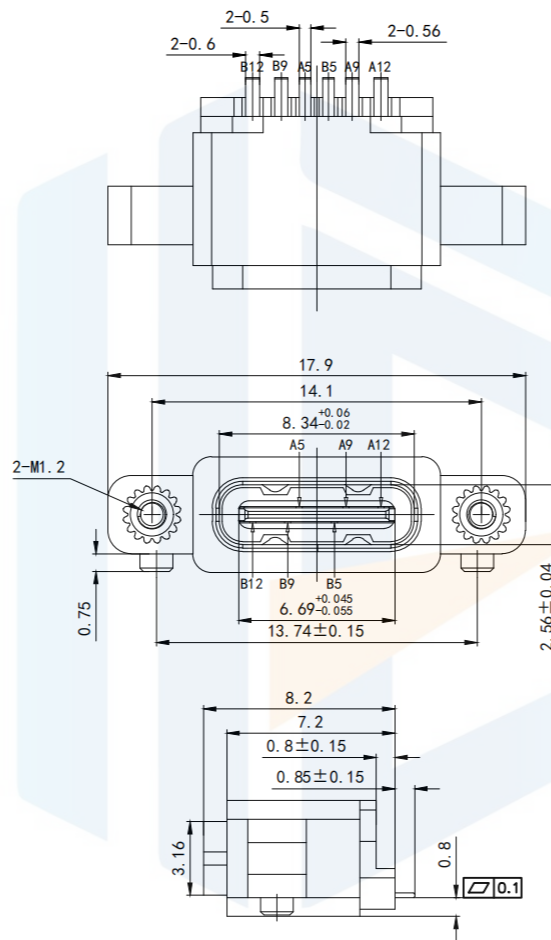

带防水圈示意图

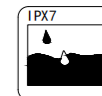
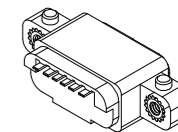
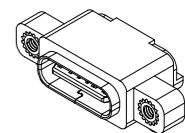

NOTES:

SPECIFICATION:

- CURRENT RATING: 3.0 A
- VOLTAGE RATING: 3.0 V
- VBUS & GND PINS AND OTHER PINS: 40mΩ/PIN MAX  
SHIELD: 50mΩ/MAX LLGR MAX. CHANGE OF ALL PINS: 10Ωm
- INSULATION RESISTANCE: 100MΩ MIN
- DIELECTRIC WITHSTAND VOLTAGE, AC 100V FOR 1MINUTE
- INSERTION FORCE: 0.5~2.0kgf
- UNMATING FORCE: 0.8-2.0kgf
- DURABILITY: 10000 CYCLES
- OPERATING TEMPERATURE: -35° C~+85° C
- THE PEAK TEMPERATURE ON THE BOARD SHALL BE MAINTAINED FOR 10 SECONDS AT 210-230° C
- WATERPROOF: IP-X7.

TOLERANCE

X. XXX	$\pm 0.05$
X. XX	$\pm 0.15$
X. X	$\pm 0.20$
X.	$\pm 0.30$
ANGLE	$\pm 5.0^\circ$

PROTECTON

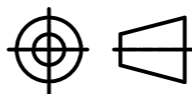

东莞市恒祺电子科技有限公司

Dongguan Hengqi Electronic Technology Co., Ltd

<https://www.hq-dz.com>

phone: 15812872448

TITLE:

TYPE C 6P 板上防水母座带螺母

PART NO: TYPE-C6P-BS1082FS

DRAWING NO: 17.9\*4.96\*8.2

DRAWN:

CHECKED:

APPROVED:

DATE:

DATE:

DATE:

18-10-08

18-10-08

18-10-08

UNIT:

mm

SCALE:

FULL

SIZE:

A4