

RoHS2.0  
Compliant

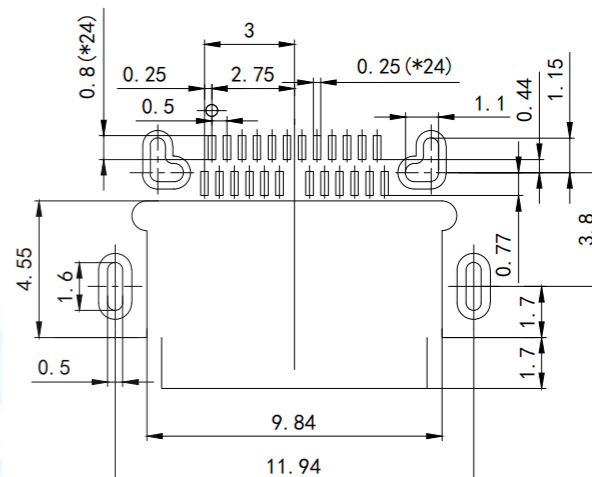

PECOMMENDED P. C. B. LAYOUT

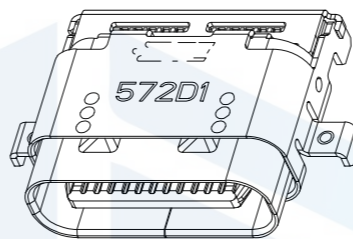
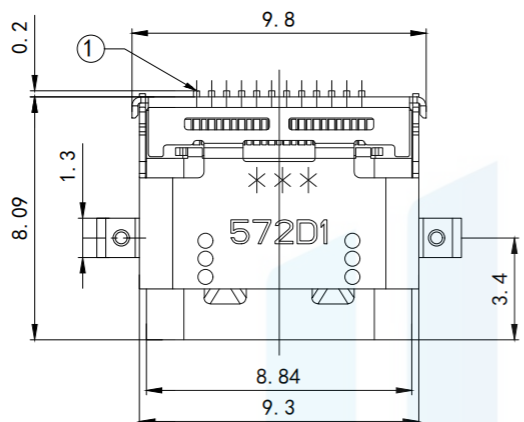
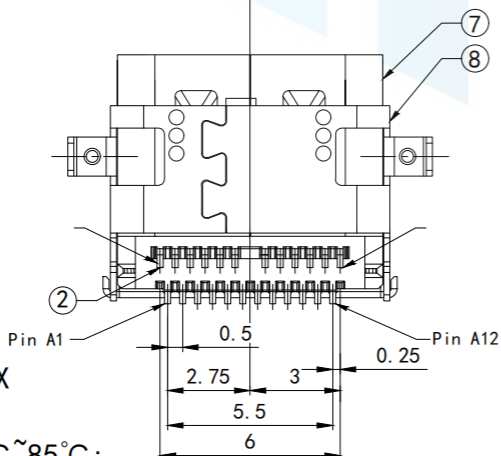
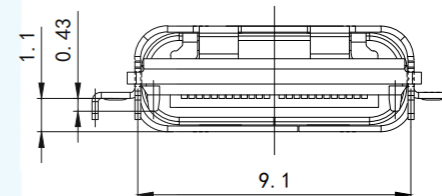
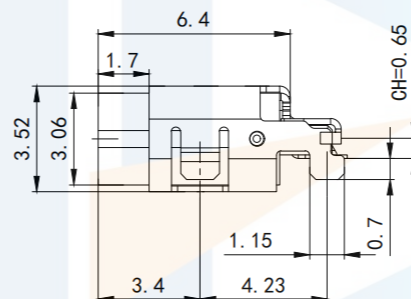
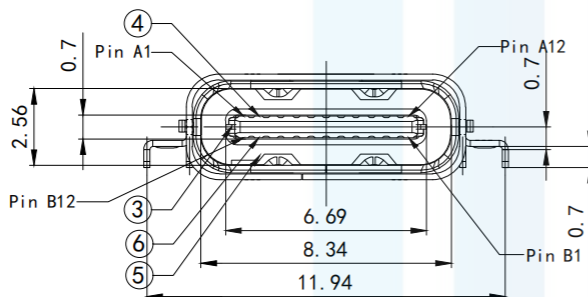

NOTES:

1. CURRENT RATING: 5.0A MAX
2. VOLTAGE: 100V AC
3. TEMPERATURE RANGE: -30°C ~ 85°C:
4. CONTACT RESISTANCE: 40 MILLIONHM MAX.
5. INSULATION RESISTANCE: 100M MEFOHMS MIN.
6. LNSERTION FORCE: 5N~20N
7. NMATING FORCE: 8N~20N
8. DURABILITY: 10,000 CYCLES.

TOLERANCE

X. XXX	±0.05
X. XX	±0.15
X. X	±0.20
X.	±0.30
ANGLE	±5.0°

PROTECTON

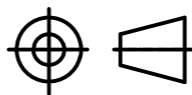

东莞市恒祺电子科技有限公司  
Dongguan Hengqi Electronic Technology Co., Ltd

<https://www.hq-dz.com>

phone: 15812872448

TITLE:

TYPE C 24PIN沉板CH=0.65  
双排全贴

PART NO: TYPE-C24P-CBX6P

DRAWING NO: 11.94\*8.09\*3.52

DRAWN:

CHECKED:

APPROVED:

DATE: 18-10-08

DATE: 18-10-08

DATE: 18-10-08

UNIT:  
mm

SCALE:  
FULL

SIZE:  
A4