

RoHS2.0
Compliant

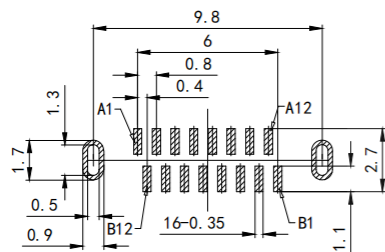

RECOMMEND P. C. B LAYOUT
TOLERANCE UNSPECIFIED ± 0.05

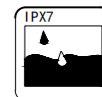
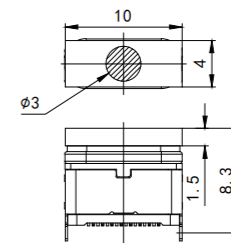
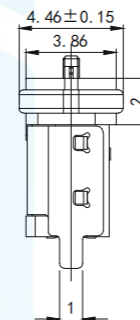
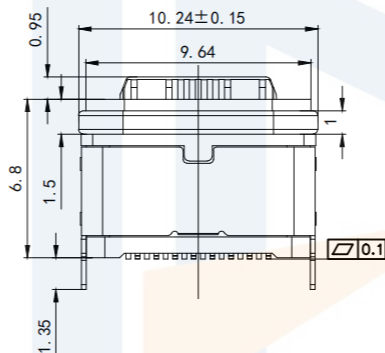
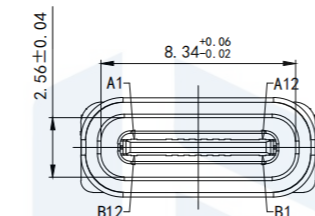

装前塞示意图

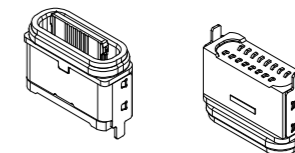
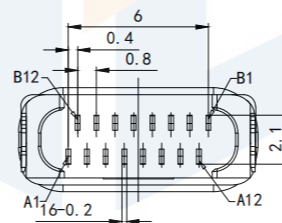
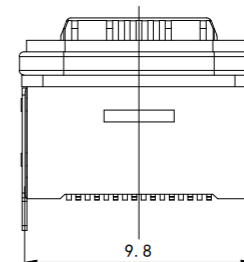

NOTES:

SPECIFICATION:

- CURRENT RATING: 3.0 A
- VOLTAGE RATING: 3.0 V
- VBUS & GND PINS AND OTHER PINS: 40mΩ/PIN MAX
SHIELD: 50mΩ/MAX LLGR MAX. CHANGE OF ALL PINS: 10Ωm
- INSULATION RESISTANCE: 100MΩ MIN
- DIELECTRIC WITHSTAND VOLTAGE, AC 100V FOR 1MINUTE
- INSERTION FORCE: 0.5~2.0kgf
- UNMATING FORCE: 0.8-2.0kgf
- DURABILITY: 10000 CYCLES
- OPERATING TEMPERATURE: -35° C~+85° C
- THE PEAK TEMPERATURE ON THE BOARD SHALL BE MAINTAINED FOR 10 SECONDS AT 210-230° C
- WATERPROOF: IP-X7.

TOLERANCE

X. XXX	±0.05
X. XX	±0.15
X. X	±0.20
X.	±0.30
ANGLE	±5.0°

PROTECTON

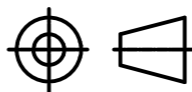

东莞市恒祺电子科技有限公司

Dongguan Hengqi Electronic Technology Co., Ltd

<https://www.hq-dz.com>

phone:15812872448

TITLE:

TYPE C 16P 防水母座立式贴板
H=6.8mm U型全塑

PART NO:TYPE-C16P-LT268FS

DRAWING NO:10.24*4.46*6.8

DRAWN:

CHECKED:

APPROVED:

DATE: 18-10-08

DATE: 18-10-08

DATE: 18-10-08

UNIT:
mm

SCALE:
FULL

SIZE:
A4