

RoHS2.0
Compliant

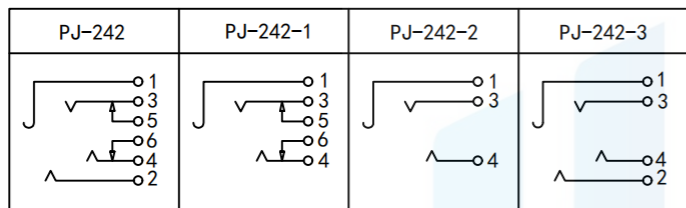

SCHEMATIC

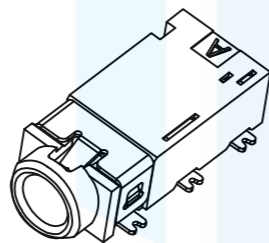
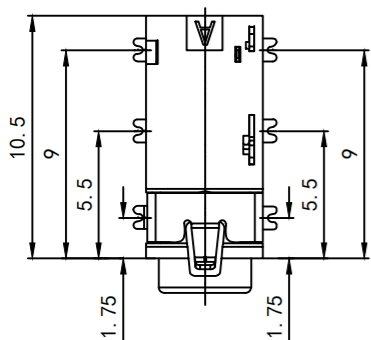
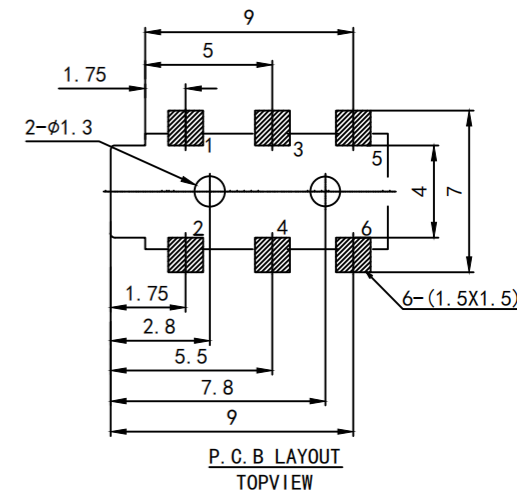
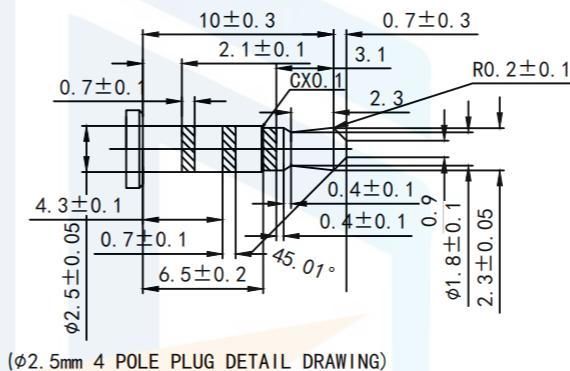

3D VIEW

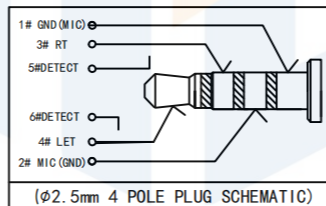

SPECIFICATION

1. Rating: DC 30V, 0.5A
2. Contact resistance: <30mΩ
3. Insulation resistance: >100MΩ
4. Withstand voltage : 500VAC
5. Insertion and extraction force: 3-20N
6. life test: 5,000 cycles

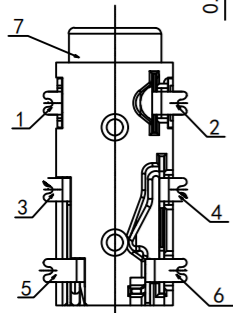
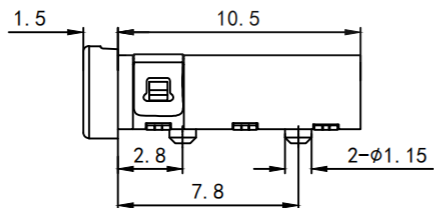
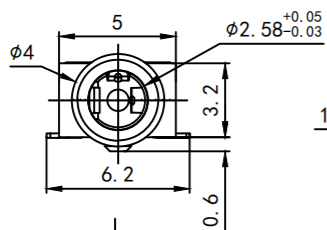

TOLERANCE	X. XXX	±0.05		东莞市恒祺电子科技有限公司		
	X. XX	±0.15		Dongguan Hengqi Electronic Technology Co., Ltd		
PROTECTON	X. X	±0.20	https://www.hq-dz.com		phone:15812872448	
	X.	±0.30	TITLE: 耳机插座		PART NO: PJ-242E	
	ANGLE	±5.0°	DRAWING NO: 12*5*3.2			
	DRAWN:		DATE:	18-10-08	UNIT: mm	
	CHECKED:		DATE:	18-10-08	SCALE: FULL	
	APPROVED:		DATE:	18-10-08	SIZE: A4	