

RoHS2.0
Compliant

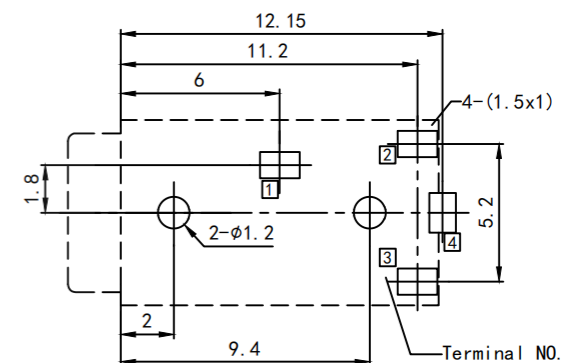
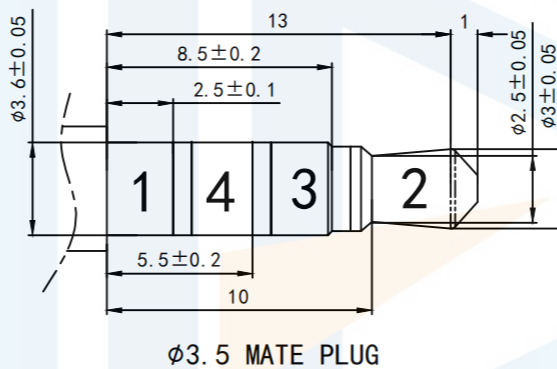
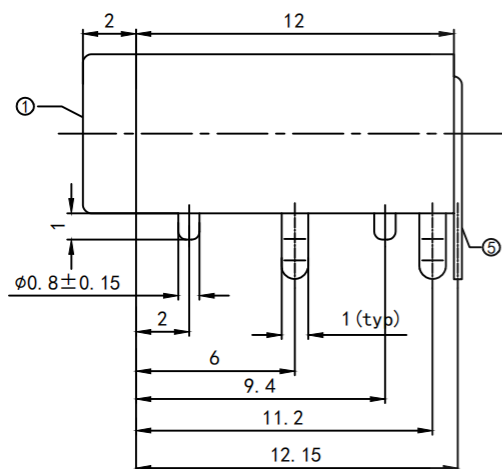
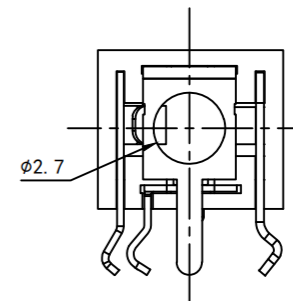
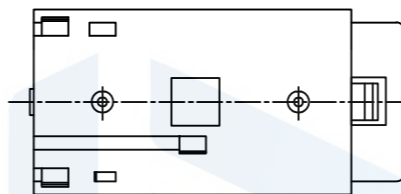
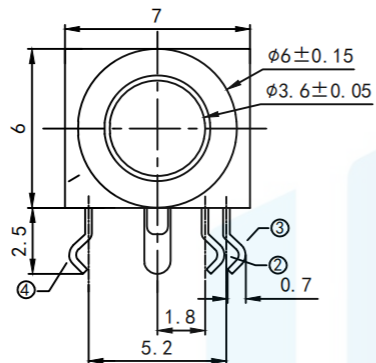

Model NO.	PJ366	PJ366-D	PJ366-E	PJ366-Z
Schematic				
				Special circuit
				□: TERMINAL NO.

SPECIFICATION

1. Rating: DC 30V 0.5A;
2. Contact resistance: <30mΩ;
3. Insulation resistance: >100MΩ (DC250V);
4. Withstand voltage: 500VAC;
5. Insertion and extraction force: 3-30N;
6. life test: 5,000 cycles

TOLERANCE

X. XXX	±0.05
X. XX	±0.15
X. X	±0.20
X.	±0.30
ANGLE	±5.0°

PROTECTON

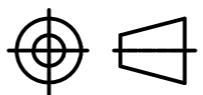

东莞市恒祺电子科技有限公司

Dongguan Hengqi Electronic Technology Co., Ltd

<https://www.hq-dz.com>

phone:15812872448

TITLE:

耳机插座

PART NO: PJ-366

DRAWING NO: 14*7*6

DRAWN:

DATE:

18-10-08

UNIT:
mm

CHECKED:

DATE:

18-10-08

SCALE:
FULL

APPROVED:

DATE:

18-10-08

SIZE:
A4