

RoHS2.0
Compliant

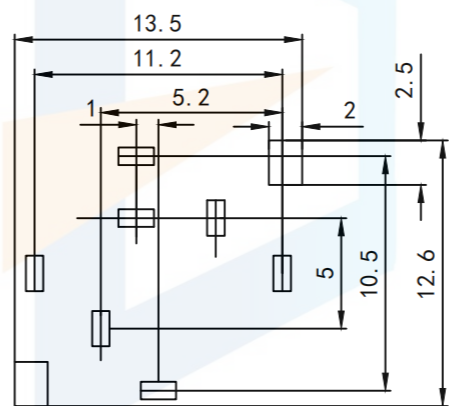

线路板安装尺寸示意图

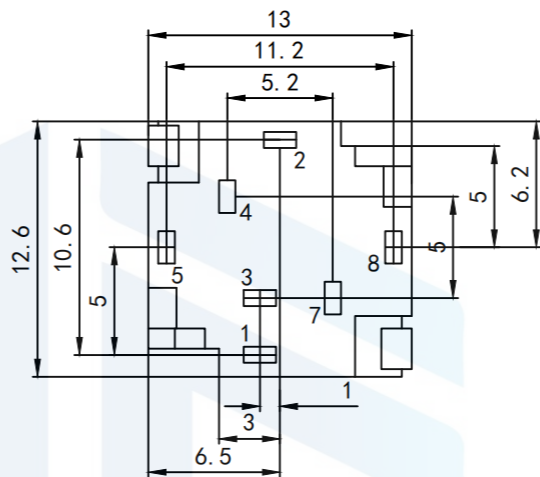
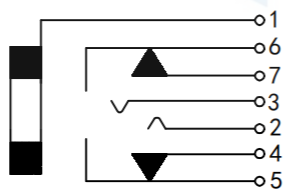
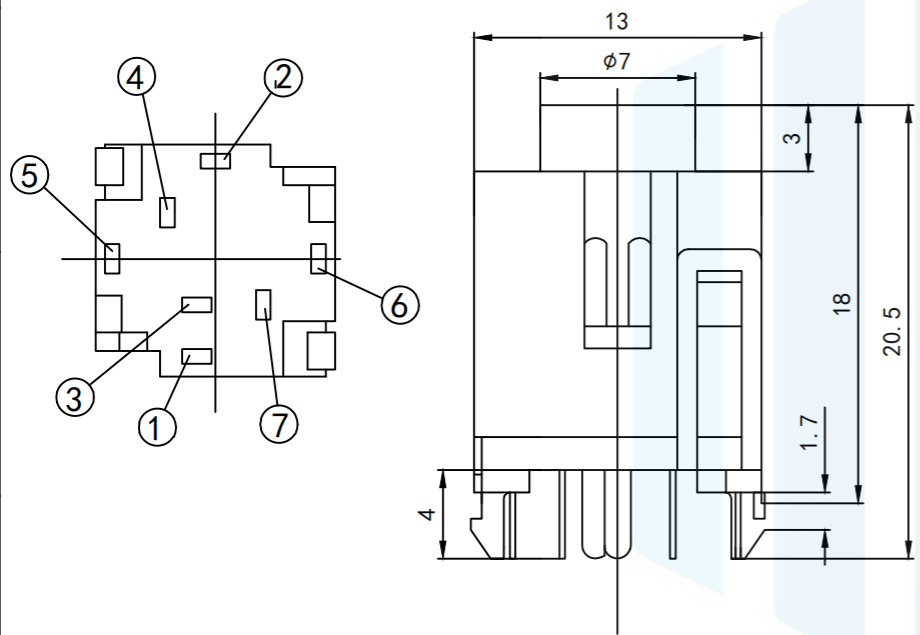
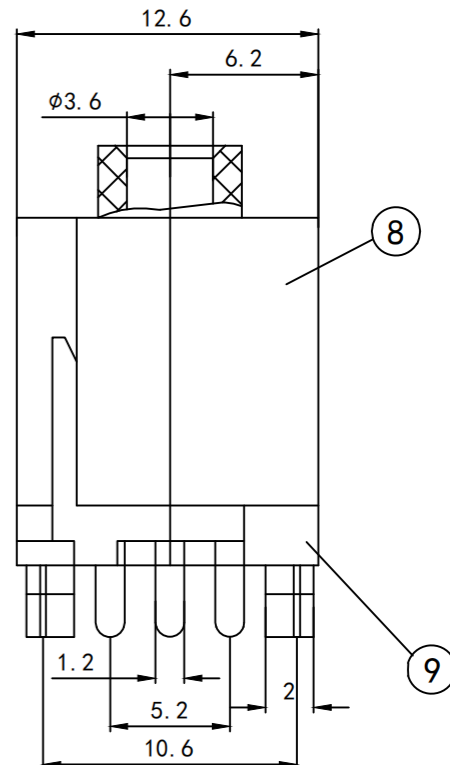

电路结构示意图

Main technical performance
 Rated electric load DC 30V \ 0.5A
 Contact resistance $S0.03\Omega$
 Insulation resistance 2100M Ω
 Withstand voltage AC500V(50Hz)/min
 Insertion and withdrawal force 3-20N
 Operating temperature range $-30-70^{\circ}\text{C}$
 Service life 5000 times

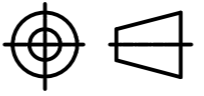
TOLERANCE	X. XXX	± 0.05	 东莞市恒祺电子科技有限公司 Dongguan Hengqi Electronic Technology Co., Ltd		
	X. XX	± 0.15			
PROTECTON	X. X	± 0.20	TITLE: 耳机插座		PART NO: PJ-344-7P
	X.	± 0.30	DRAWING NO: 18*12.6*13		DATE: 18-10-08
	ANGLE	$\pm 5.0^{\circ}$	DRAWN:	DATE: 18-10-08	UNIT: mm
			CHECKED:	DATE: 18-10-08	SCALE: FULL
			APPROVED:	DATE: 18-10-08	SIZE: A4