

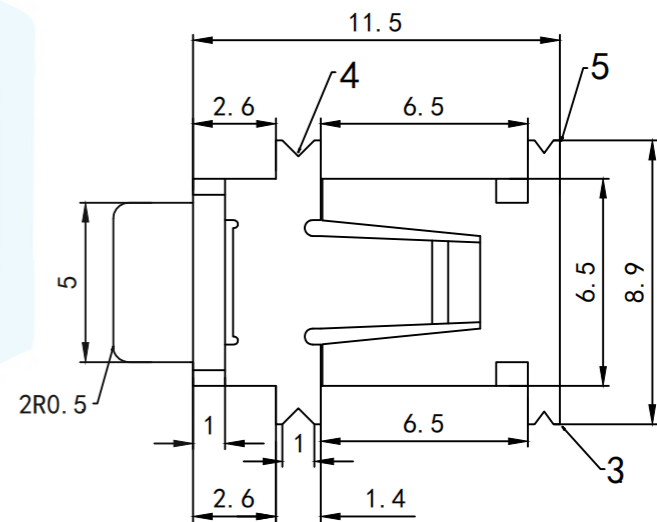

RoHS2.0
Compliant

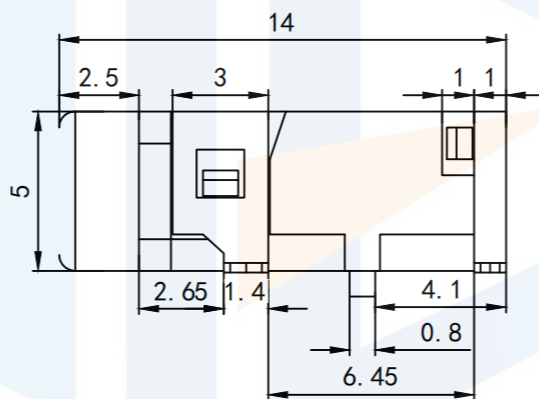
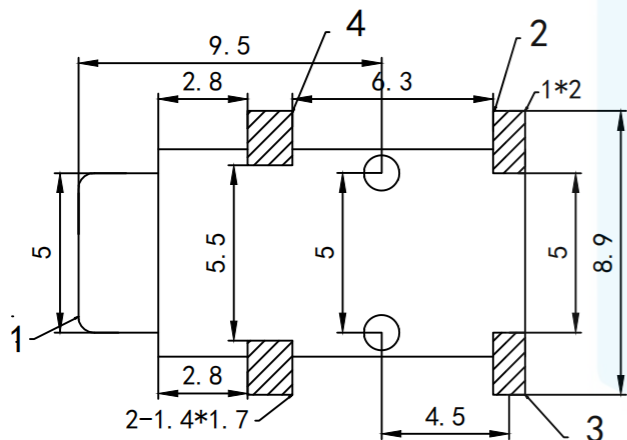
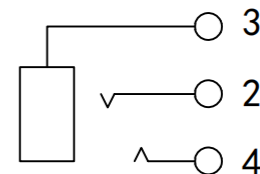
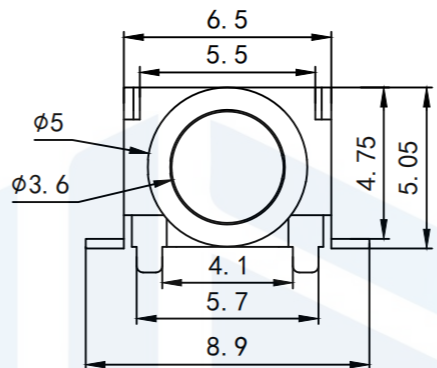
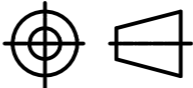

Technical requirements:
 Rated voltage: DC15v 20mA
 Operating temperature: -30~70°C
 Insertion and removal force: 3~20N
 Life: 5,000
 Tolerance: ±0.02

TOLERANCE		 东莞市恒祺电子科技有限公司 Dongguan Hengqi Electronic Technology Co., Ltd	
X. XXX	±0.05		
X. XX	±0.15	https://www.hq-dz.com	
X. X	±0.20	phone: 15812872448	
X.	±0.30	TITLE: 耳机插座	
ANGLE	±5.0°	PART NO: PJ-321	
PROTECTON 		DRAWN:	
		CHECKED:	
		DATE: 18-10-08	
		UNIT: mm	
APPROVED:		DATE: 18-10-08	
		SCALE: FULL	
		DATE: 18-10-08	
		SIZE: A4	