

RoHS2.0  
Compliant

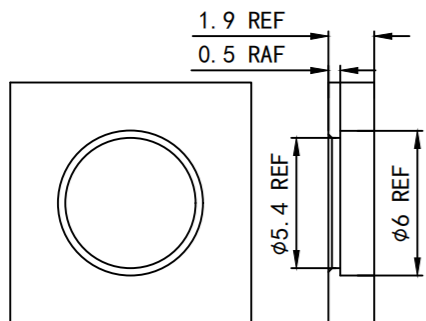

面板开孔参考尺寸

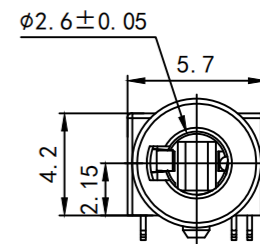
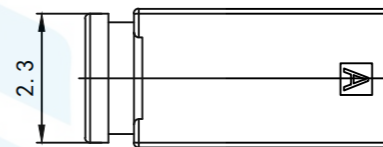
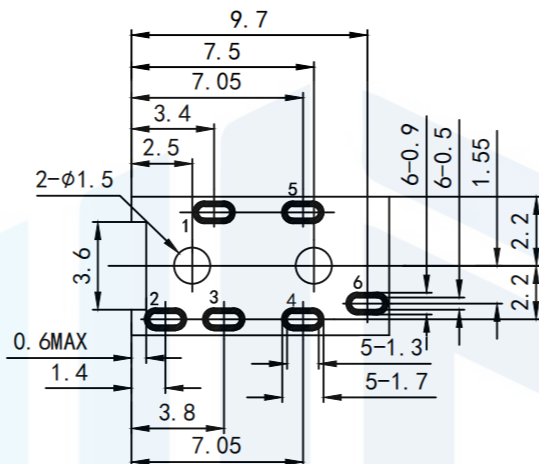

NOTES

- CURRENT RATING: 1A.
- CONTACT RESISTANCE: 100mΩ MAX.
- INSULATION RESISTANCE: 100MΩ MIN.
- DIELECTRIC WITHSTANDING: 500V AC MIN.
- DURABILITY: 5000 CYCLES MIN.
- CONNECTOR MATING FORCES: 3~30N.
- CONNECTOR UNMATING FORCES: 3~30N.
- OPERATING TEMPERATURE: -25° C TO +85° C.
- WATERPROOF LEVEL: IP67

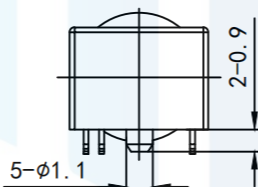
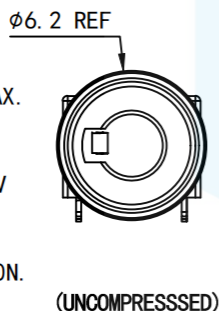

RECOMMEND PCB LAYOUT  
TOLERANCE: ±0.05

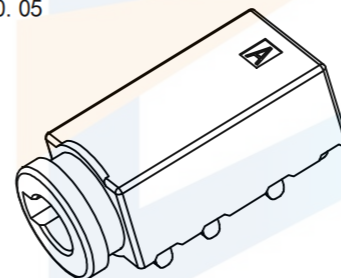

3D VIEW

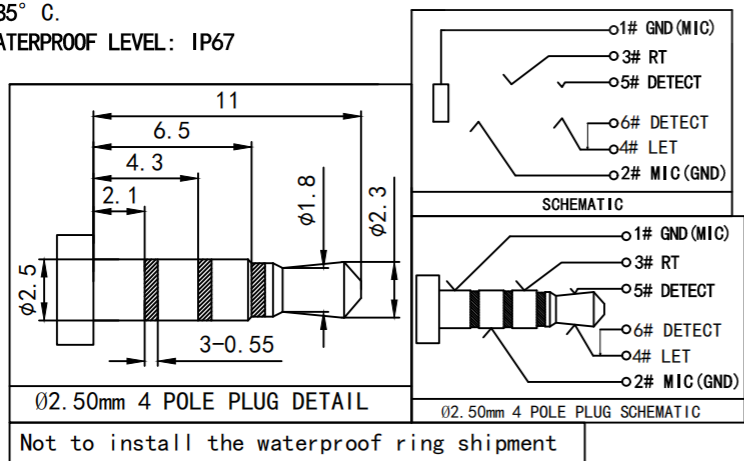
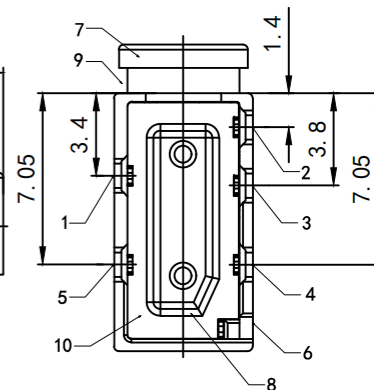
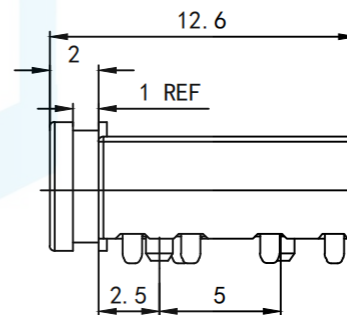

Not to install the waterproof ring shipment

TOLERANCE	X. XXX	±0.05		东莞市恒祺电子科技有限公司	
	X. XX	±0.15		Dongguan Hengqi Electronic Technology Co., Ltd	
	X. X	±0.20	https://www.hq-dz.com		phone:15812872448
	X.	±0.30	TITLE: 防水耳机插座		PART NO: PJ-1202
	ANGLE	±5.0°	DRAWING NO: 12.6*5.7*4.2		
PROTECTON	DRAWN:		DATE:	18-10-08	UNIT: mm
	CHECKED:		DATE:	18-10-08	SCALE: FULL
	APPROVED:		DATE:	18-10-08	SIZE: A4